



**METERING INSTRUMENTS**  
DIGITAL MULTIMETERS AND ENERGY METERS  
NETWORK ANALYZERS  
DATA CONCENTRATOR  
COMMUNICATION DEVICES

**ENERGY METERS**  
DIRECT CONNECTION  
OR BY CURRENT  
TRANSFORMERS  
MID CERTIFIED VERSIONS



# EMM $\mu$ D3VA | $\mu$ 3VA | R3VA

DIGITAL MEASURING INSTRUMENTS - **VOLTMETER / AMMETER**

Voltage and current measures in True RMS

Storage of minimum, maximum and average(max demand) values

Connection by external CT

Measure in medium voltage by programming the voltage transformer (VT) ratio



TECHNICAL CHARACTERISTICS		EMM- $\mu$ D3VA	EMM- $\mu$ 3VA	EMM-R3VA
<b>AUXILIARY SUPPLY</b>				
Nominal voltage Us		230VAC	400VAC	400VAC
Operating voltage range		$\pm 15\%$	$\pm 15\%$	$\pm 15\%$
Power consumption		3VA	3VA	3VA
Frequency		50 - 60 Hz	45 - 65 Hz	45 - 65 Hz
<b>VOLTAGE INPUTS</b>				
Measurement range		20...500VAC L-L (20...380VAC L-N)	300...500VAC L-L (175...290VAC L-N)	300...500VAC L-L (175...290VAC L-N)
Method of measuring		True RMS value	True RMS value	True RMS value
Measuring input impedance		1M $\Omega$	1M $\Omega$	1M $\Omega$
Method of connection		Single-phase, two-phase, three-phase orbanced three-phase system	Single-phase, two-phase, three-phase orbanced three-phase system	Single-phase, two-phase, three-phase orbanced three-phase system
<b>CURRENT INPUTS</b>				
Reference current		1A (option) or 5A	1A (option) or 5A	1A (option) or 5A
Measurement range		0,02...5A	0,02...5A	0,02...5A
Method of measuring		True RMS value	True RMS value	True RMS value
Overload capacity		+50% by an external current transformer	+30% by an external current transformer	+30% by an external current transformer
Self-consumption		< 0,5VA	< 0,5VA	< 0,5VA
<b>ACCURACY</b>				
Measures	Voltage	0,5%	0,5%	0,5%
	Current	0,5%	0,5%	0,5%
	Frequency	0,5%	0,5%	0,5%
<b>INSULATION</b>				
Insulation voltage		3kVAC for 1 minute	3kVAC for 1 minute	3kVAC for 1 minute
<b>AMBIENT CONDITION</b>				
Storage temperature		-10...+60°C	-10...+60°C	-10...+60°C
Storage temperature		-25...+70°C	-25...+70°C	-25...+70°C
<b>HOUSING</b>				
Version		3 modules (DIN 50022)	Flush mount 72 x 72 mm	Flush mount 96 x 96 mm
Degree of protection		IP42 on front IP20 Housing and terminals	IP52 on front IP20 Housing and terminals	IP52 on front IP20 Housing and terminals
Weight		400g	500g	500g
<b>CERTIFICATIONS AND COMPLIANCE</b>				
Reference standards		IEC/EN 50081-2, IEC/EN 61000-6-2, IEC/EN 61010-1		

# EMM $\mu$ D3VA | $\mu$ 3VA | R3VA

DIGITAL MEASURING INSTRUMENTS - VOLTMETER / AMMETER

OPTIONS	
ORDER CODE	DESCRIPTION
C1	Auxiliary Supply 230 V
C2	Auxiliary Supply 115 V
1A	Rated current inputs by external CT 1A
T	Internal current inputs, galvanically insulated
P	2 digital outputs

## WIRING DIAGRAMS EMM- $\mu$ D3VA

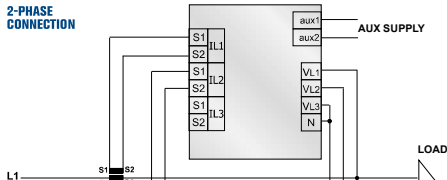
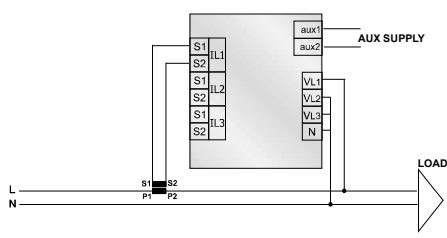
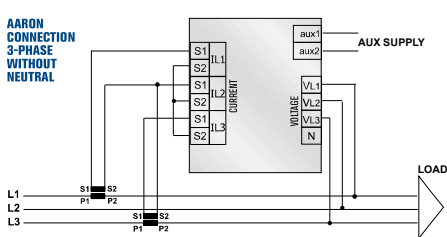
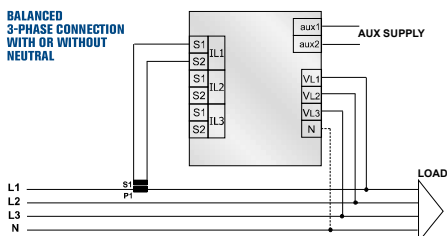
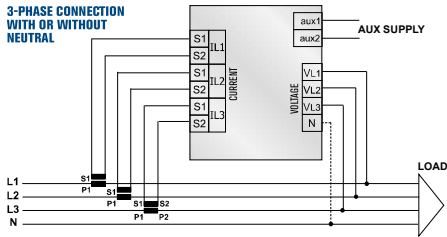

## MECHANICAL DIMENSIONS EMM- $\mu$ D3VA

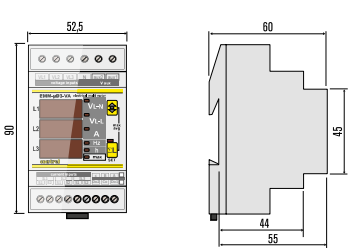

## WIRING DIAGRAMS EMM- $\mu$ 3VA e EMM-R3VA

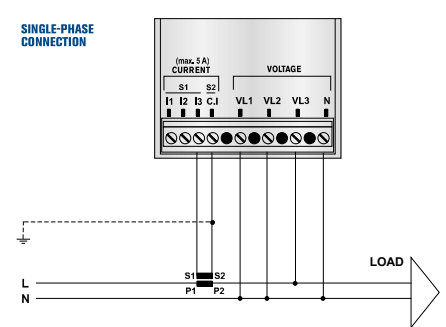
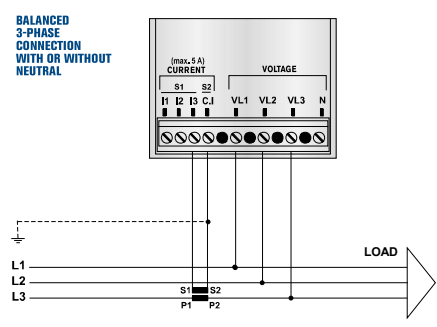
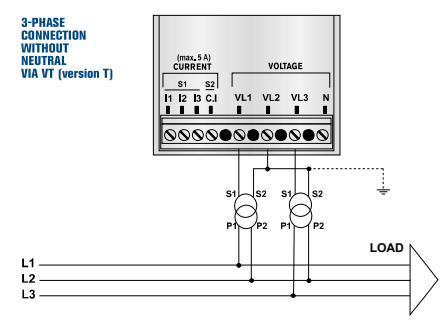
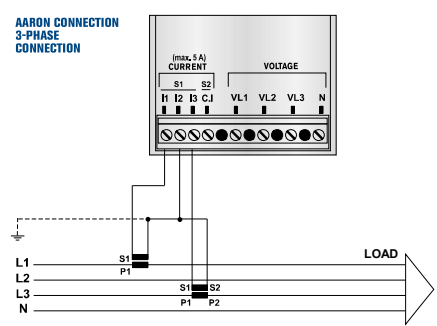
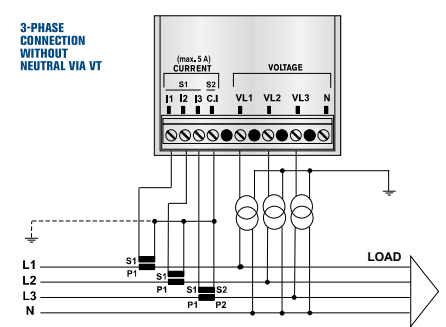
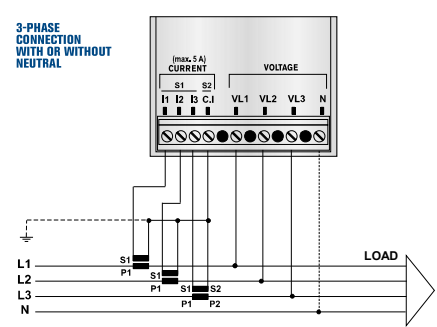

## MECHANICAL DIMENSIONS EMM- $\mu$ 3VA

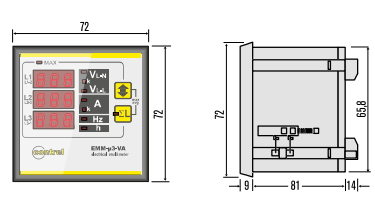

## MECHANICAL DIMENSIONS EMM-R3VA

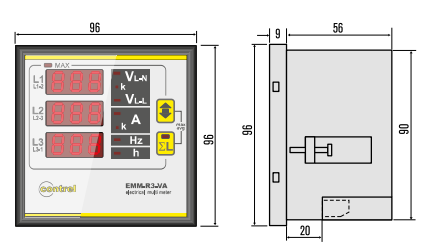

# EMM 4h | $\mu$ 4h | R4h

## DIGITAL MEASURING INSTRUMENTS - FLUSH MOUNT LED MULTIMETERS



TECHNICAL CHARACTERISTICS		EMM-4h	EMM- $\mu$ 4h	EMM- R4h
<b>AUXILIARY SUPPLY</b>				
Nominal voltage $U_s$		110 - 230 - 400 VAC	400VAC (directly by the voltage inputs)	400VAC (directly by the voltage inputs)
Operating voltage range		$\pm 15\%$	$\pm 15\%$	$\pm 15\%$
Power consumption		4VA	3VA	3VA
Frequency		50 - 60 Hz	45 - 65 Hz	45 - 65 Hz
<b>VOLTAGE INPUTS</b>				
Measurement range		20...500VAC L-L (20...290VAC L-N)	20...500VAC L-L (20...290VAC L-N)	20...500VAC L-L (20...290VAC L-N)
Method of measuring		True RMS value	True RMS value	True RMS value
Measuring input impedance		1M $\Omega$	1M $\Omega$	1M $\Omega$
Method of connection		Single-phase, two-phase, three-phase orbanced three-phase system	Single-phase, two-phase, three-phase orbanced three-phase system	Single-phase, two-phase, three-phase orbanced three-phase system
<b>CURRENT INPUTS</b>				
Reference current		1A (option) or 5A	1A (option) or 5A	1A (option) or 5A
Measurement range		0,02...5A	0,02...5A	0,02...5A
Method of measuring		True RMS value	True RMS value	True RMS value
Overload capacity		+20% by an external current transformer	+20% by an external current transformer	+20% by an external current transformer
Self-consumption		< 0,5VA	< 0,5VA	< 0,5VA
<b>ACCURACY</b>				
Measures	Voltage	0,5%	0,5%	0,5%
	Current	0,5%	0,5%	0,5%
	Power	1 %	1 %	1 %
	Frequency	0,5%	0,5%	0,5%
	Active energy	Class 1	Class 1	Class 1
<b>INSULATION</b>				
Insulation voltage		3kVAC for 1 minute	3kVAC for 1 minute	3kVAC for 1 minute
<b>AMBIENT CONDITION</b>				
Storage temperature		-10...+60°C	-10...+60°C	-10...+60°C
Storage temperature		-25...+80°C	-25...+80°C	-25...+80°C
<b>HOUSING</b>				
Version		Flush mount 96 x 96 mm	Flush mount 72 x 72 mm	Flush mount 96 x 96 mm
Degree of protection		IP42 on front IP20 Housing and terminals	IP52 on front IP20 Housing and terminals	IP52 on front IP20 Housing and terminals
Weight		500g	500g	500g
<b>CERTIFICATIONS AND COMPLIANCE</b>				
Reference standards		IEC/EN 50081-2, IEC/EN 61000-6-2, IEC/EN 61010-1, IEC/EN 61036-1		
<b>OPTIONS</b>				
ORDER CODE	DESCRIPTION			
C1	Auxiliary Supply 20 $\pm$ 60 VAC/CC (version EMM-4h) - Auxiliary Supply 230 VAC (versions EMM-R4h, EMM- $\mu$ 4h)			
C2	Auxiliary Supply 90 $\pm$ 250 VAC/CC (version EMM-4h) - Auxiliary Supply 110 VAC (versions EMM-R4h, EMM- $\mu$ 4h)			
600	Voltage Inputs 600 V (version EMM-4h)			
1A	Rated Current inputs by external CT 1A			
T	Internal Current inputs, galvanically insulated			



# EMM 4h | $\mu$ 4h | R4h

## DIGITAL MEASURING INSTRUMENTS - FLUSH MOUNT LED MULTIMETERS

<b>TT - TTA</b>	Current inputs by miniaturized closed CT (TT) or openable CT (TTA)
<b>N</b>	Neutral current input or differential current input
<b>M</b>	Import/Export energy counters
<b>P</b>	2 digital outputs
<b>DI</b>	1 digital input
<b>A</b>	1 analog outputs
<b>COMMUNICATION PORTS</b>	
<b>485</b>	RS485 serial interface
<b>ETH</b>	Ethernet interface with Web server function (version EMM-4h)
<b>PF/S</b>	Profibus-DP interface (version EMM-4h)
<b>M-Bus</b>	M-Bus interface (version EMM-4h)
<b>LON</b>	LON-Works interface (version EMM-4h)

### WIRING DIAGRAMS EMM-4h

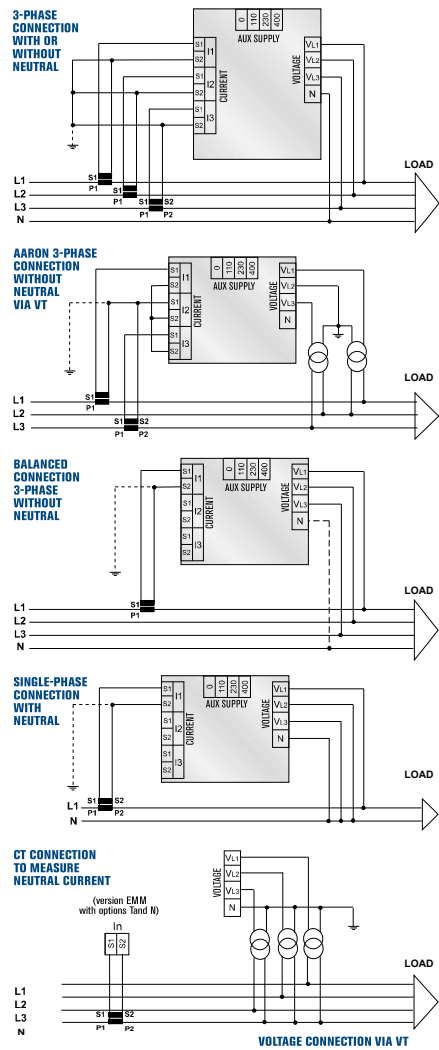

### MECHANICAL DIMENSIONS EMM-4h

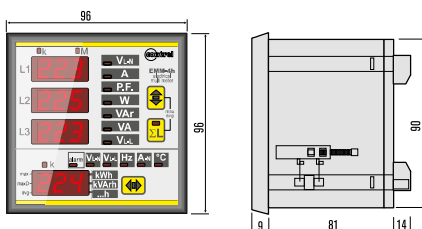

### WIRING DIAGRAMS EMM- $\mu$ 4h e EMM-R4h

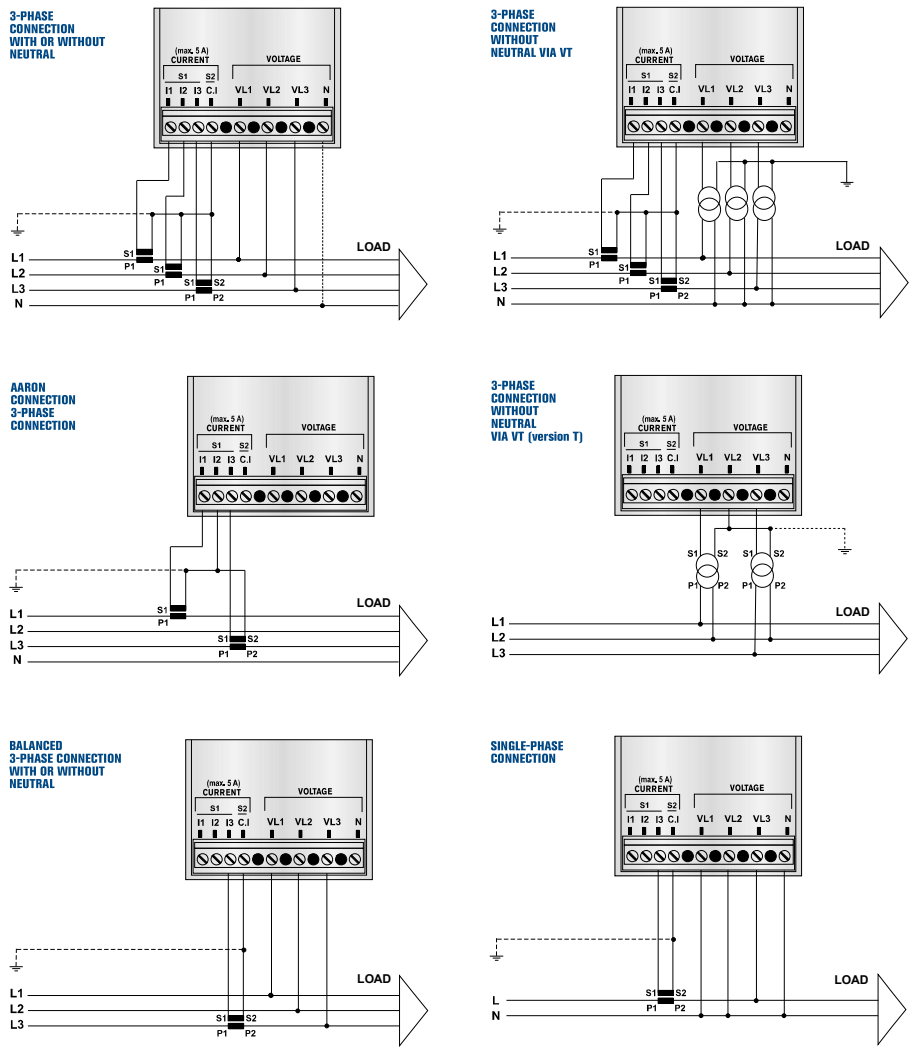

### MECHANICAL DIMENSIONS EMM- $\mu$ 4h

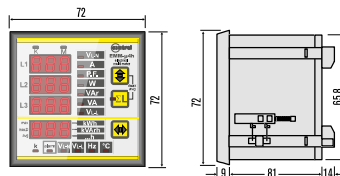

### MECHANICAL DIMENSIONS EMM-R4h

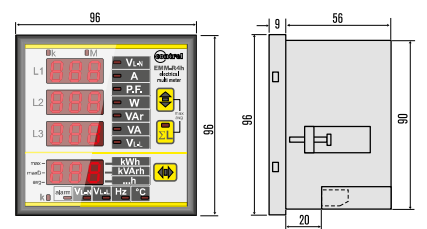

# EMM 4dc | 4d2c

DIGITAL MEASURING INSTRUMENTS  
**FLUSH MOUNT**  
**LED MULTIMETERS**  
**FOR DC NETWORKS**



TECHNICAL CHARACTERISTICS		EMM-4dc	EMM-4d2c
<b>AUXILIARY SUPPLY</b>			
Nominal voltage Us		110 - 230 - 380 VAC	110 - 230 - 380 VAC
Operating voltage range		±10%	±10%
Power consumption		4VA	4VA
Frequency		50 - 60 Hz	50 - 60 Hz
<b>VOLTAGE INPUTS</b>			
Measurement range		5...200 VDC	5...200 VDC
Measuring input impedance		1 MΩ	1 MΩ
Method of connection		Line with a common negative voltage and the second shunt inputs Line with a negative common voltage and shunt 1 entrance Line with positive common voltage and 2 shunt inputs Line with only shunt inputs Line for only voltage input	
<b>CURRENT INPUTS</b>			
Connection type		Through SHUNT / HALL sensor (option)	Through SHUNT / HALL sensor (option)
Shunt range		1...60mV 1...150mV (option)	1...60mV 1...150mV (option)
<b>ACCURACY</b>			
Measures	Voltage	Class 0,5 ± 1 digit	Class 0,5 ± 1 digit
	Current	Class 0,5 ± 1 digit	Class 0,5 ± 1 digit
	Power	Class 1 da ± 1 digit	Class 1 da ± 1 digit
	Active energy	Class 1	Class 1
<b>INSULATION</b>			
Insulation voltage		3kVAC for 1 minute	3kVAC for 1 minute
<b>AMBIENT CONDITION</b>			
Operating temperature		-10...+60°C	-10...+60°C
Storage temperature		-25...+80°C	-25...+80°C
<b>HOUSING</b>			
Version		Flush mount 96 x 96 mm	Flush mount 96 x 96 mm
Degree of protection		IP52 on front IP20 Housing and terminals	IP52 on front IP20 Housing and terminals
Weight		500g	500g
<b>CERTIFICATIONS AND COMPLIANCE</b>			
Reference standards		EN 61010-1	EN 61010-1

OPTIONS	
ORDER CODE	DESCRIPTION
C1	Auxiliary supply 20÷60 VAC/VCC
C2	Auxiliary supply 90÷250 VAC/VCC
P	2 digital outputs
DI	1 digital input
HE	Input current Hall sensor
PT100	Temperature input PT100 sensor (version EMM-4d2c)
COMMUNICATION PORTS	
485	RS485 serial interface

# EMM 4dc | 4d2c

DIGITAL MEASURING INSTRUMENTS

FLUSH MOUNT LED MULTIMETERS FOR DC NETWORKS

	EMM-4dc				EMM-4d2c			
	IST	MAX	AVG	MD	IST	MAX	AVG	MD
Voltage	•	•	•	-	•	•	-	-
Current	•	•	•	•	•	•	•	•
Active power	•	•	•	•	-	-	-	-
Active energy counter	TOTAL / PARTIAL				-			
Temperature			•		•	•	-	-
Hour counter			•				•	

IST = Instantaneous value / MAX = Highest peak of the instantaneous value / AVG = Time-integrated value / MD = Maximum peak of the integrated value (max demand)

## WIRING DIAGRAMS

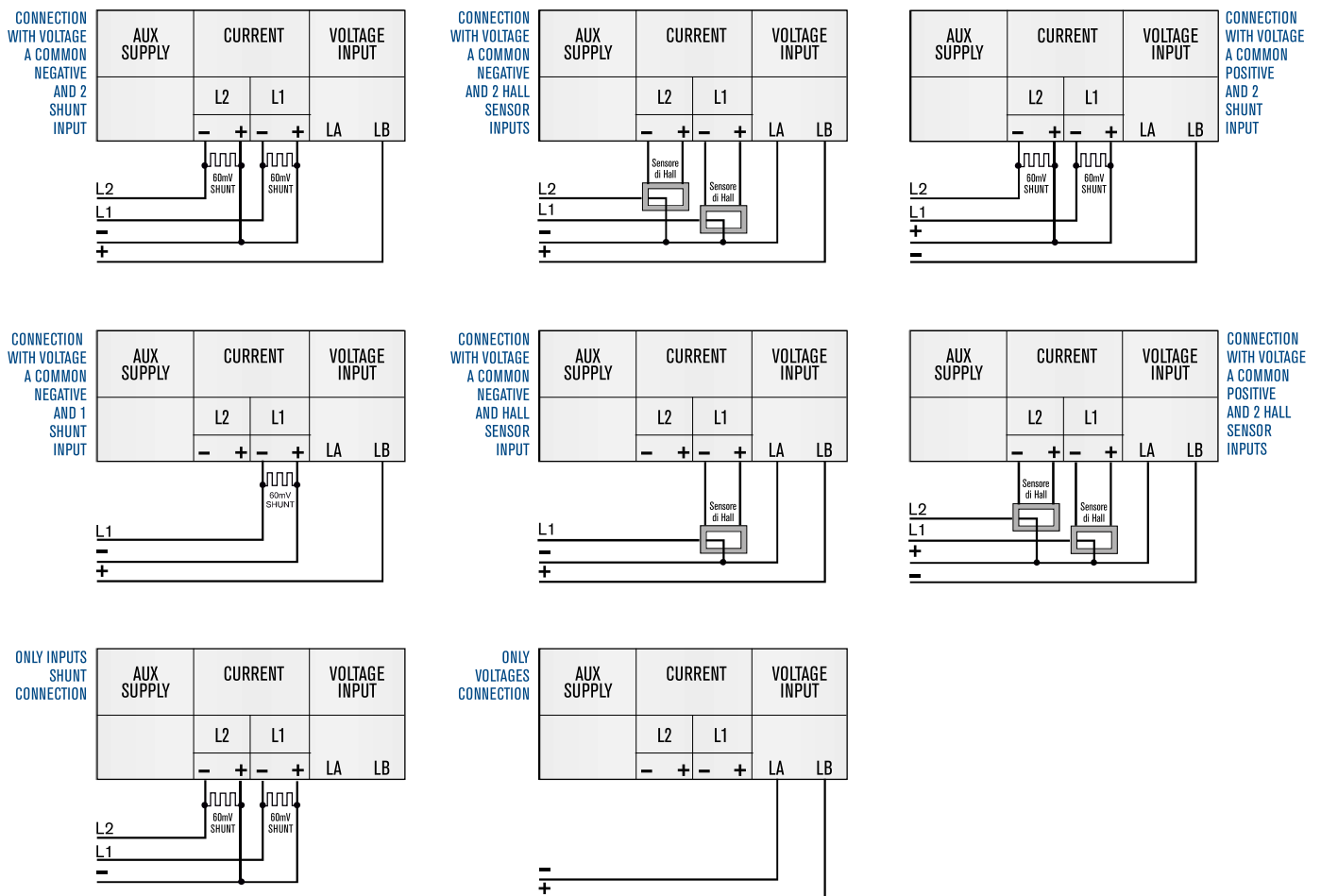

## MECHANICAL DIMENSIONS EMM-4dc

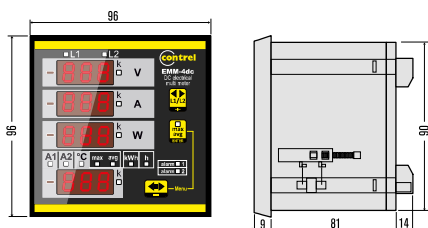

## MECHANICAL DIMENSIONS EMM-4d2c

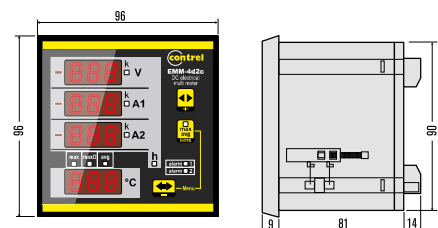

# ELM 4

## DIGITAL MEASURING INSTRUMENTS AMMETER FOR CURRENTS LINE OR DIFFERENTIAL CURRENTS

Ammeter for measuring differential or residual currents (up to four simultaneously) using an external toroidal or for the measurement of the line currents (possibly also separate lines between them) using appropriate external CT.



TECHNICAL CHARACTERISTICS		ELM-4
<b>AUXILIARY SUPPLY</b>		
Nominal voltage Us		110 - 230 - 400 VAC
Operating voltage range		±15%
Power consumption		3VA
Frequency		50 - 60 Hz
<b>VOLTAGE INPUTS</b>		
Measurement range		52...693VAC L-L (30...400VAC L-N)
Method of measuring		True RMS value
Measuring input impedance		1 MΩ
Method of connection		Single-phase, two-phase, three-phase or balanced three-phase system
<b>CURRENT INPUTS</b>		
Reference current		5A
Measurement range		0,05...5A
Method of measuring		True RMS value
Overload capacity		+30% by an external current transformer
Self-consumption		< 0,5VA
<b>ACCURACY</b>		
Measures	Voltage	-
	Current	0,5%
	Power	-
	Frequency	-
	Active energy	-
<b>INSULATION</b>		
Insulation voltage		3kVAC for 1 minute
<b>AMBIENT CONDITION</b>		
Operating temperature		-10...+60°C
Storage temperature		-25...+80°C
<b>HOUSING</b>		
Version		Flush mount 96 x 96 mm
Degree of protection		IP52 on front - IP20 Housing and terminals
Weight		500g
<b>CERTIFICATIONS AND COMPLIANCE</b>		
Reference standards		IEC/EN 50081-2, IEC/EN 61000-6-2, IEC/EN 61010-1, IEC/EN 61036-1
<b>OPTIONS</b>		
ORDER CODE	DESCRIPTION	
C1	Auxiliary supply 20÷60 VAC/DC	
C2	Auxiliary supply 85÷230 VAC/DC	
CT5	Current inputs by external CT 5A	
CT1	Rated current inputs by external CT 1A	
DO	2 digital outputs	
A	1 analog output	
<b>COMMUNICATION PORTS</b>		
485	RS485 serial interface	



# ELM 4

DIGITAL MEASURING INSTRUMENTS

## AMMETER FOR CURRENTS LINE OR DIFFERENTIAL CURRENTS

### WIRING DIAGRAMS - DIFFERENTIAL CURRENT INPUTS

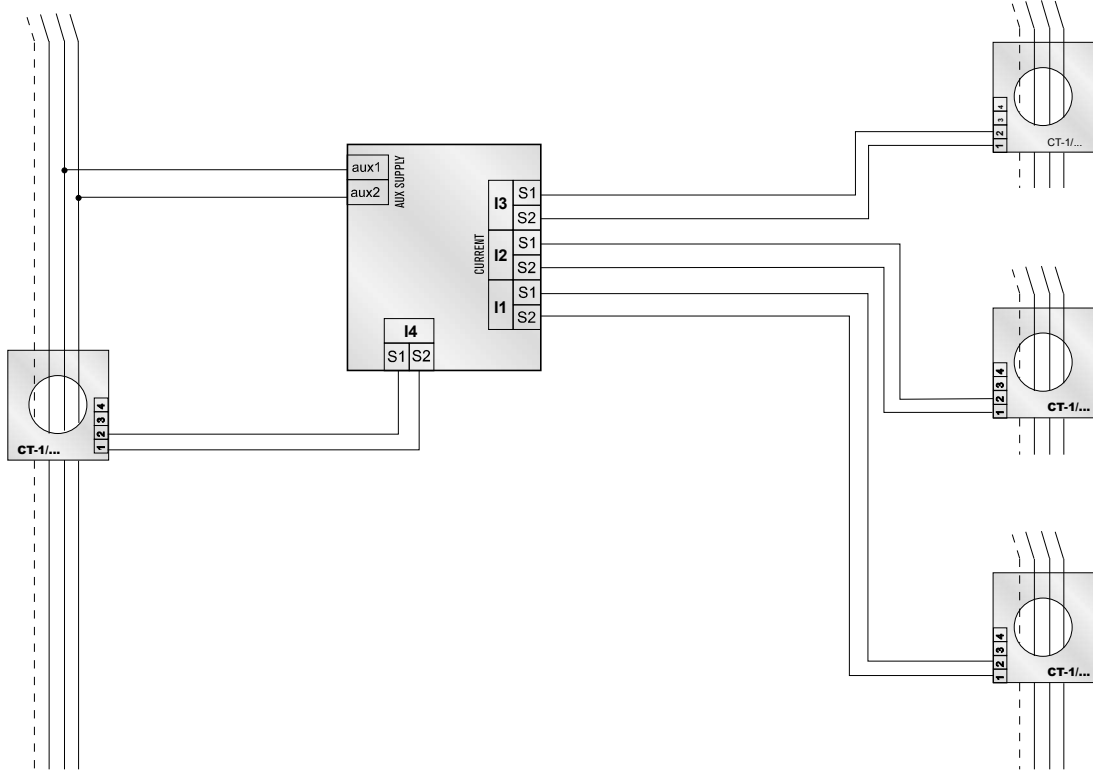

### WIRING DIAGRAMS - CURRENT INPUTS BY EXTERNAL CT

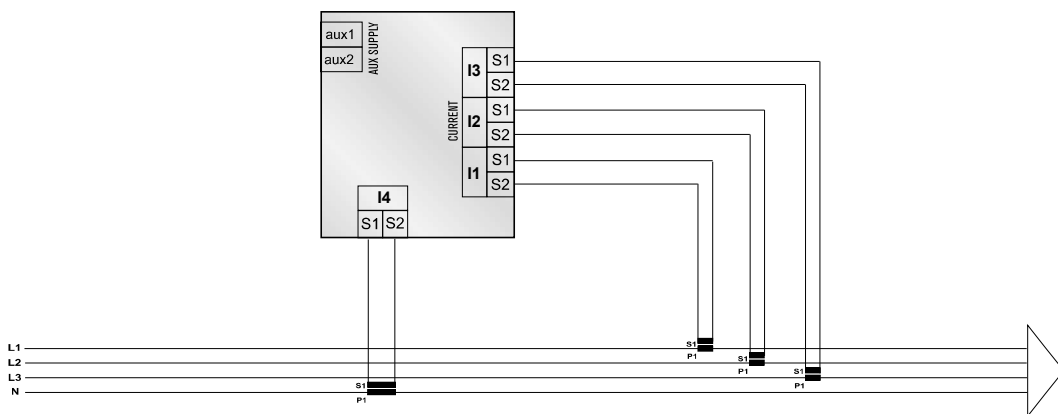

### MECHANICAL DIMENSIONS ELM 4

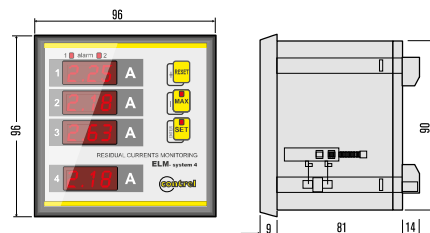

# EMM D4h | $\mu$ D3h

DIGITAL MEASURING INSTRUMENTS

## MODULAR LED MULTIMETERS



TECHNICAL CHARACTERISTICS		EMM-D4h	EMM- $\mu$ D3h
<b>AUXILIARY SUPPLY</b>			
Nominal voltage Us		110 - 230 - 400 VAC	230VAC
Operating voltage range		$\pm 15\%$	$\pm 15\%$
Power consumption		4VA	4VA
Frequency		50 - 60 Hz	50 - 60 Hz
<b>VOLTAGE INPUTS</b>			
Measurement range		20...500VAC L-L (20...290VAC L-N)	20...500VAC L-L (20...290VAC L-N)
Method of measuring		True RMS value	True RMS value
Measuring input impedance		1M $\Omega$	1M $\Omega$
Method of connection		Single-phase, two-phase, three-phase or balanced three-phase system	Single-phase, two-phase, three-phase or balanced three-phase system
<b>CURRENT INPUTS</b>			
Reference current		1A (option) or 5A	1A (option) or 5A
Measurement range		0,02...5A	0,02...5A
Method of measuring		True RMS value	True RMS value
Overload capacity		+30% by an external current transformer	+30% by an external current transformer
Self-consumption		< 0,5VA	< 0,5VA
<b>ACCURACY</b>			
Measures	Voltage	0,5%	0,5%
	Current	0,5%	0,5%
	Power	1 %	1 %
	Frequency	0,5%	0,5%
	Active energy	Class 1	Class 1
<b>INSULATION</b>			
Insulation voltage		3kVAC for 1 minute	3kVAC for 1 minute
<b>AMBIENT CONDITION</b>			
Operating temperature		-10...+60°C	-10...+60°C
Storage temperature		-25...+80°C	-25...+80°C
<b>HOUSING</b>			
Version		6 modules	3 modules
Degree of protection		IP52 on front IP20 Housing and terminals	IP52 on front IP20 Housing and terminals
Weight		500g	300g
<b>CERTIFICATIONS AND COMPLIANCE</b>			
Reference standards		IEC/EN 50081-2, IEC/EN 61000-6-2, IEC/EN 61010-1, IEC/EN 61036-1	
<b>OPTIONS</b>			
ORDER CODE	DESCRIPTION		
C1	Auxiliary supply 20÷60 VAC/DC (version EMM-D4h) - Auxiliary supply 400 VAC (versions EMM- $\mu$ D3h)		
C2	Auxiliary supply 90÷250 VAC/DC (version EMM-D4h) - Auxiliary supply 110 VAC (versions EMM- $\mu$ D3h)		
1A	Rated current inputs by external CT 1A		
T	Internal current inputs, galvanically insulated (version EMM-D4h)		
TT - TTA	Current inputs by miniaturized closed CT (TT) or openable CT (TTA)		
N	Neutral current input or differential current input (version EMM-D4h)		

# EMM D4h | $\mu$ D3h

DIGITAL MEASURING INSTRUMENTS - MODULAR LED MULTIMETERS

OPTIONS	
ORDER CODE	DESCRIPTION
<b>M</b>	Import/Export energy counters
<b>P</b>	2 digital outputs
<b>DI</b>	1 digital inputs (version EMM-D4h)
<b>A</b>	1 analog output (version EMM-D4h)

  

COMMUNICATION PORTS	
<b>485</b>	RS485 serial interface
<b>ETH</b>	1 digital inputs (version EMM-D4h)
<b>LON</b>	1 analog output (version EMM-D4h)

## WIRING DIAGRAMS EMM-D4h

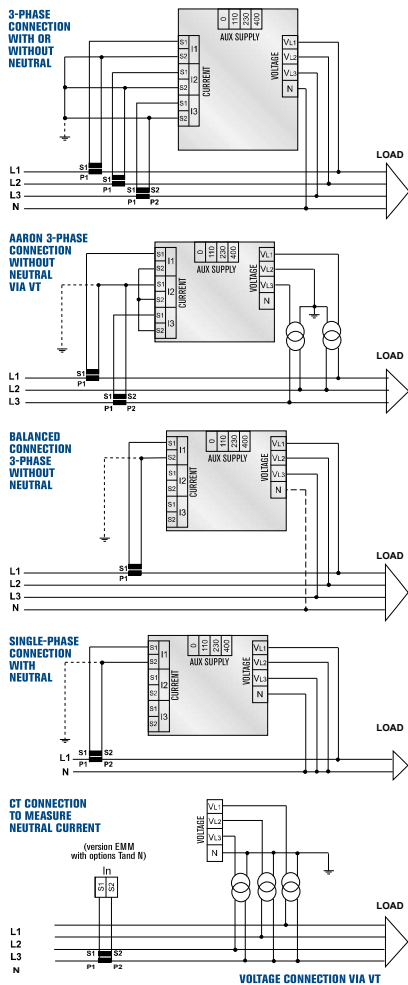

## MECHANICAL DIMENSIONS EMM-D4h

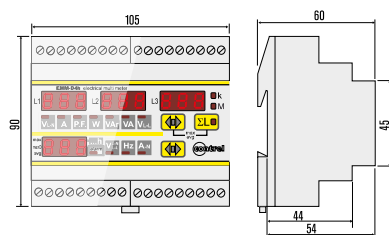

## WIRING DIAGRAMS EMM- $\mu$ D3h

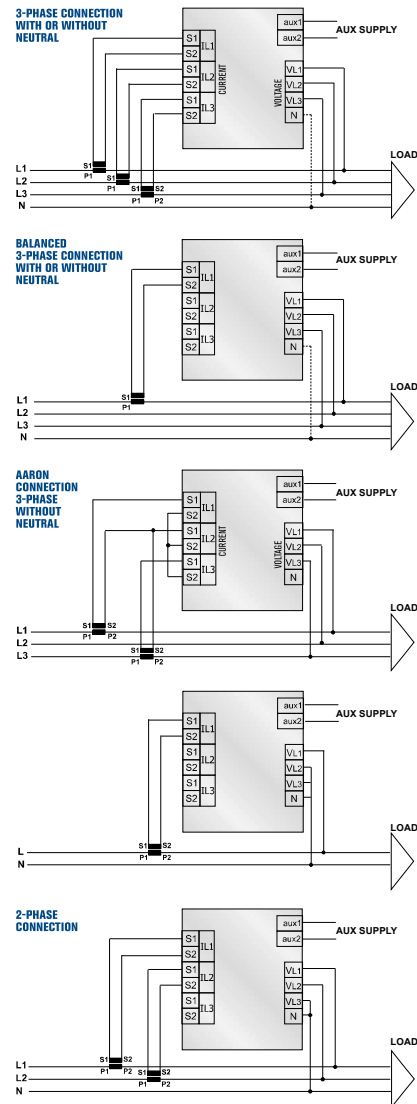

## MECHANICAL DIMENSIONS EMM- $\mu$ D3h

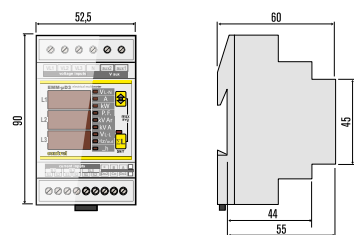

# EMT 4s

## DIGITAL MEASURING INSTRUMENTS MEASUREMENT TRANSDUCER

The EMT-4s is the transducer version of the EMS-96, for DIN-rail mount. This device has the same characteristics as the EMS-96, but has no color display. Instead of the integrated display, the EMT-4s has an interface board that consent the connection in one of the following modes:

- RS485 communication port
- Remote display communication port



TECHNICAL CHARACTERISTICS		EMT-4s
<b>AUXILIARY SUPPLY</b>		
Nominal voltage Us		110 - 230 - 400 VAC
Operating voltage range		±15%
Power consumption		3VA
Frequency		50 - 60 Hz
<b>VOLTAGE INPUTS</b>		
Measurement range		52...693VAC L-L (30...400VAC L-N)
Method of measuring		True RMS value
Measuring input impedance		1,8MΩ
Method of connection		Single-phase, two-phase, three-phase or balanced three-phase system
<b>CURRENT INPUTS</b>		
Reference current		1A (option), 30A (option) or 5A
Measurement range		0,05...5A
Method of measuring		True RMS value
Overload capacity		6A by an external current transformer
Self-consumption		<0,5VA
<b>ACCURACY</b>		
Measures	Voltage	0,5%
	Current	0,5%
	Power	1 %
	Frequency	0,5%
	Active energy	Class 1
<b>RS485 SERIAL INTERFACE</b>		
Baud-rate		Programmable 4800...38400 bps
Protocol		Modbus RTU
<b>INSULATION</b>		
Insulation voltage		3kVAC for 1 minute
<b>AMBIENT CONDITION</b>		
Operating temperature		-5...+50°C
Storage temperature		-15...+60°C
<b>HOUSING</b>		
Version		6 modules
Degree of protection		IP52 on front IP20 Housing and terminals
Weight		430g
<b>CERTIFICATIONS AND COMPLIANCE</b>		
Reference standards		EN61000-6-2, EN61000-6-4, CISPR22-EN55022, EN62053-21, EN62053-22, EN62053-23
<b>OPTIONS</b>		
ORDER CODE	DESCRIPTION	
1A	Rated current inputs by external CT 1A	
TT - TTA	Current inputs by miniaturized closed CT (TT) or openable CT (TTA)	
N	Neutral current input or differential current input	
0.5 s	Active energy Class 0.5s	
0.2 s	Active energy Class 0.2s	
4DI	4 digital inputs	
4DO	4 digital outputs	
<b>COMMUNICATION PORTS</b>		
485	RS485 serial interface	
485M	RS485 serial interface (Master function)	



# EMT 4s

DIGITAL MEASURING INSTRUMENTS  
MEASUREMENT TRANSDUCER

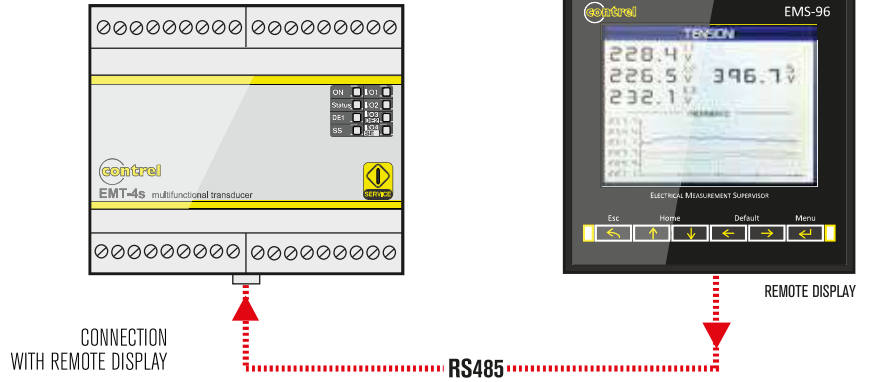

## WIRING DIAGRAMS EMT-4s

**SINGLE-PHASE 2 WIRE CONNECTION**

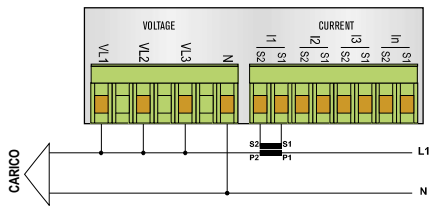

**SINGLE-PHASE 2 WIRE CONNECTION MULTIPLE LOADS**

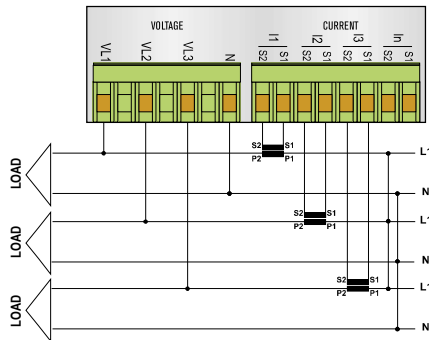

**MULTIPLE SINGLE-PHASE CONNECTION MULTIPLE LOADS**

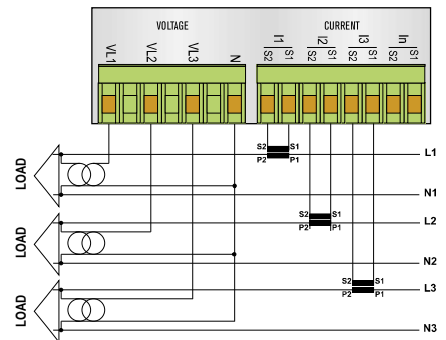

**2-PHASE CONNECTION WITH NEUTRAL**

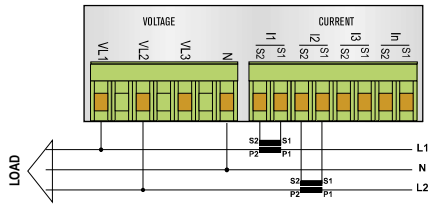

**3-PHASE CONNECTION WITH NEUTRAL**

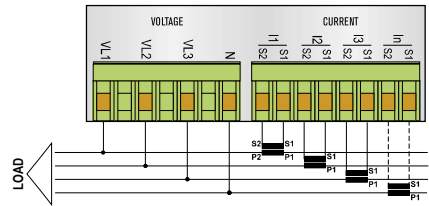

**AARON CONNECTION 3-PHASE WITHOUT NEUTRAL**

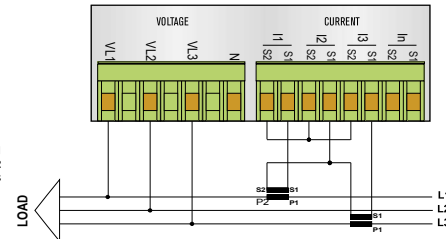

**BALANCED 3-PHASE CONNECTION WITH NEUTRAL**

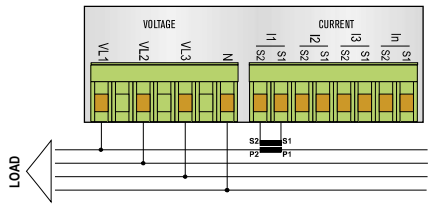

**BALANCED 3-PHASE CONNECTION MULTIPLE LOADS**

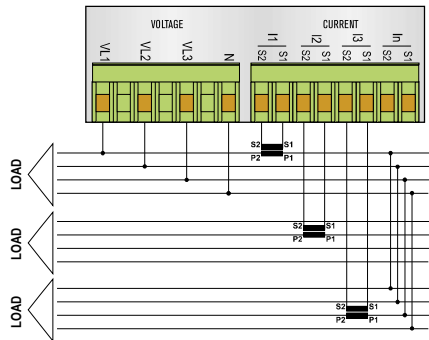

## MECHANICAL DIMENSIONS EMT-4s

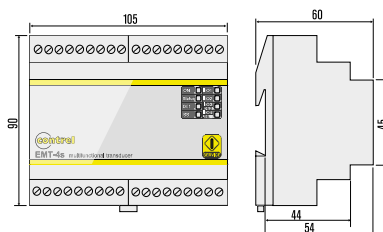

# EMT-1C/50 | 1C/300

DIGITAL MEASURING INSTRUMENTS  
**MODULAR  
 MEASUREMENT  
 TRANSDUCER**



TECHNICAL CHARACTERISTICS		EMT-1C/50	EMT-1C/50 LV	EMT-1C/300	EMT-1C/300 LV
<b>AUXILIARY SUPPLY</b>					
Nominal voltage $U_s$		9...30 VDC		9...30 VDC	
Operating voltage range		-		-	
Power consumption		< 1,3W		< 1,3W	
Frequency		50 - 60 Hz		50 - 60 Hz	
<b>VOLTAGE INPUTS</b>					
Measurement range		Up to 800 VAC or 1000 VDC	Up to 80 VAC or 100 VDC	Up to 800 VAC or 1000 VDC	Up to 80 VAC or 100 VDC
Method of measuring		True RMS value		True RMS value	
<b>CURRENT INPUTS</b>					
Measurement range		Fino a 50A AC/DC		Fino a 300A AC o 400A DC	
Method of measuring		True RMS value		True RMS value	
<b>ACCURACY</b>					
Measures	Voltage	0,5%		0,5%	
	Current	0,5%		0,5%	
	Power	0,5%		0,5%	
	Frequency	± 0,1		± 0,1	
	Active energy	Class 1		Class 1	
<b>RS485 SERIAL INTERFACE</b>					
Baud-rate		Programmable 1200 - 115200 bps		Programmable 1200 - 115200 bps	
Protocol		Modbus RTU		Modbus RTU	
<b>INSULATION</b>					
Insulation voltage		3 kV on bare wire for current measure 4 kV for Voltage measure		3 kV on bare wire for current measure 4 kV for Voltage measure	
<b>AMBIENT CONDITION</b>					
Operating temperature		-15...+65°C		-15...+65°C	
Storage temperature		-40...+85°C		-40...+85°C	
<b>HOUSING</b>					
Version		DIN rail clips for vertical/horizontal mounting		DIN rail clips for vertical/horizontal mounting	
Filling		Epoxy resin		Epoxy resin	
Degree of protection		IP20		IP20	
Weight		80g		370g	
<b>CERTIFICATIONS AND COMPLIANCE</b>					
Reference standards		EN61000-6-4/2006 + A1 2011; EN64000-6-2/2005 ; EN61010-1/2010		EN61000-6-4/2006 + A1 2011; EN64000-6-2/2005 ; EN61010-1/2010	

## MOUNTING

The EMT-1C can be mounted in any position (see photo below), horizontal or vertical mounting, horizontal or vertical through the two hooks for DIN rail included in the box.

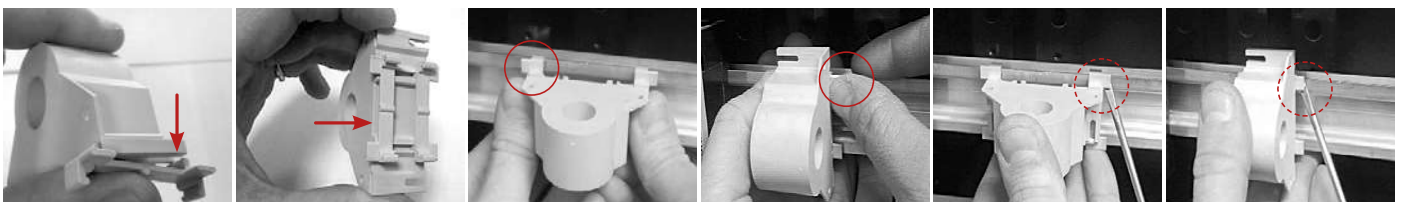

# EMT-1C/50 | 1C/300

## DIGITAL MEASURING INSTRUMENTS MODULAR MEASUREMENT TRANSDUCER

### EMT-1C/50

The EMT-1C/50 is a Single-phase Power meter able to measure TRMS Current AC/DC, and Voltage.

On the RS485 Modbus are available : Irms, Vrms, Watt, Var, Va, Vpk, Ipk, Frequency, Cosφ, Energy bidirectional and THD.  
The device is fully configurable by RS485.

#### CHARACTERISTICS:

- TRMS Measure, THD available
- 0,5 % Accuracy
- RS485 Modbus integrated
- Bidirectional Energy metering
- Din rail mounting in both side
- Fully configurable by interface software
- Bootloader for updating firmware

### EMT-1C/50 LV

The EMT-1C/50-LV is the LOW VOLTAGE version of the Single-phase Power meter EMT-1C/50, able to measure the RMS AC or DC Current and Voltage.  
On the RS485 Modbus are available:

Irms, Vrms, Watt, Var, Va, Vpk, Ipk, Frequency, Cosφ, Energy bidirectional and THD.  
The device is fully configurable by RS485.

#### CHARACTERISTICS:

- LOW VOLTAGE VERSION
- TRMS Measure, THD available
- 0,5% Accuracy;
- RS485 Modbus integrated;
- Bidirectional Energy metering
- Din-rail mounting in both side
- Fully configurable by interfacesoftware
- Available measure register: MSW first, LSW first or hundredts

### EMT-1C/300

The EMT-1C/300 is an Energy / Power Meter capable of measuring single-phase current and voltage AC RMS/ DC.  
RS485 Modbus with over 200 registers.

Measure available: Irms, Vrms, Watt, Var, Va, Vpk, Ipk, Frecuenza, Cosφ, Import/Export energy, THD, min/MAX of RMS measurement.

Suitable for measurements with varying frequencies (Wind, Hydro, Shipbuilding Industries, Aviation), Telecommunication applications, Refrigeration, Motors.  
Suitable for direct measurements between inverter and motor.

### EMT-1C/300 LV

The EMT-1C/300-LV is the LOW VOLTAGE version of the Energy / Power Meter EMT-1C/300, capable of measuring single-phase current and voltage AC/DC TRMS.  
RS485 Modbus with over 200 registers.

Measure available: Measure available: Irms, Vrms, Watt, Var, Va, Vpk, Ipk, Frecuenza, Cosφ, Import/Export energy, THD, min/MAX of RMS measurement.

#### WIRING DIAGRAMS EMT-1C/50 E EMT-1C/300

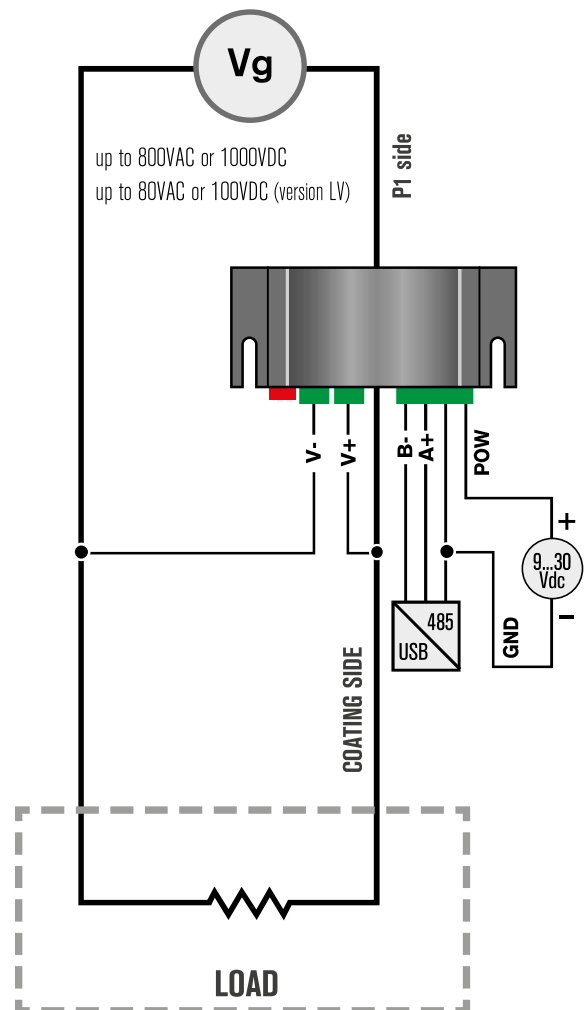

#### MECHANICAL DIMENSIONS EMT-1C/50

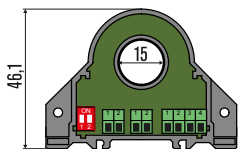

#### MECHANICAL DIMENSIONS EMT-1C/300

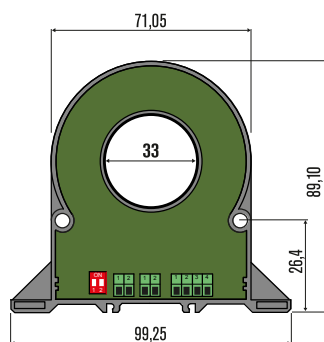

# EMI 1 | 1R

COMMUNICATION DEVICES - RS232/RS485 CONVERTER



EMI 1



EMI 1R

TECHNICAL CHARACTERISTICS	EMI 1 - 1R
<b>AUXILIARY SUPPLY</b>	
Rated voltage Us	230VAC
Operating limits	±20%
Power consumption	7VA max
Frequency	50 - 60 Hz
<b>RS232 SERIAL INTERFACE</b>	
Data format	Serial asynchronous uart/nrz
Line length	15 m MAX
Type of terminal	DB-9
<b>RS485 SERIAL INTERFACE</b>	
Baud rate	1000 m MAX
USB 2.0	57600 bit/s MAX
<b>USB 2.0</b>	
Consumption	50 mA MAX
Voltage	4.25 ... 5.25 VDC
Terminals	MINI-B
<b>INSULATION</b>	
Insulation voltage	3.7kVAC for 1 minute
<b>AMBIENT CONDITION</b>	
Operating temperature	-20...+60°C
Storage temperature	-20...+80°C
<b>HOUSING</b>	
Version	4 modules
Degree of protection	IP20
Weight	300g
<b>CERTIFICATIONS AND COMPLIANCE</b>	
Reference standards	EN 50081-1, EN 50082-2

OPTIONS	DESCRIPTION
<b>Emi-1</b>	RS232/RS485 converter, opto-isolated, 220-240VAC power supply (110-120VAC on request). Repeater drive for RS485 bus extension.
<b>Emi-1R</b>	RS232/RS485 converter DIN-rail mounting, opto-isolated, 220-240VAC power supply (110-120VAC on request). Repeater drive for RS485 bus extension.
<b>Emi-1R USB</b>	USB/RS485 converter DIN-rail mounting, opto-isolated, 220-240VAC power supply (110-120VAC on request). Repeater drive for RS485 bus extension.

Converter that can interface "slave" devices connected in an RS485 bus with a "master" equipped with RS232 interface port. When configured appropriately, it can also be used as RS485 repeater whenever the devices connected to the bus are many or the maximum distance among the bus devices is longer than the allowed. **Instead RS232 serial interface can provide USB port.**

## MECHANICAL DIMENSIONS EMI-1R

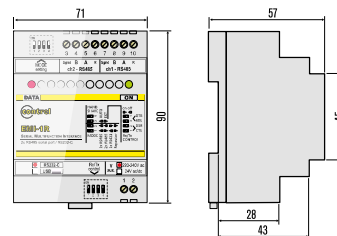

TECHNICAL CHARACTERISTICS	EMI 1P-USB
<b>AUXILIARY SUPPLY</b>	
Rated voltage Us	From PC 5V @ 100mA
Type of connection	USB
<b>RS485 SERIAL INTERFACE</b>	
Type of terminal	Screw (removable)
Baud-rate	Max baud-rate 500Kbit/s
<b>AMBIENT CONDITION</b>	
Operating temperature	-10...+65°C
Storage temperature	-15...+80°C
<b>HOUSING</b>	
Degree of protection	IP20
Weight	100 g
<b>CERTIFICATIONS AND COMPLIANCE</b>	
Reference standards	EN 61000-6-4 / N 64000-6-2 EN 61010-1 / EN 60742

## EMI-1P USB

DIGITAL MEASURING INSTRUMENTS  
USB/RS485 CONVERTER

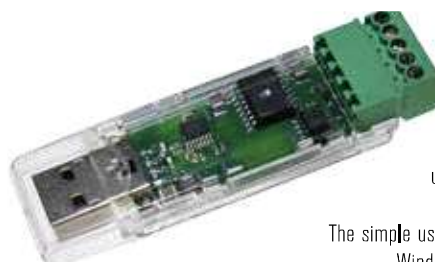

The EMI-1P USB is a Serial Converter Isolated up to 2.5kV, based on chip USB FTDI.

The simple use is guaranteed by the Windows validation drivers that you download automatically when you have your PC connected to the network. This device allows you to connect in a safe way to any Modbus devices on RS485.



# EMI 3m

## COMMUNICATION DEVICES - MODEM GSM-GPRS

**EMI-3m** is an industrial DIN rail GSM modem for the transfer of data, SMS and faxes in GSM networks. Control by ITU, GSM, GPRS and Custom AT commands. EMI-3m come with either a Serial or USB interface and its modular enclosure fits easily into equipment or machinery. Designed to operate in harsh conditions, simplifies the development of M2M and IoT application. Quad band GSM / GPRS / EDGE communication with automatic or manual selection on bands 850 / 900 / 1800 / 1900 MHz for data, sms, fax and voice applications. Full Type Approved and compliant with ETSI GSM Phase 2+ and with Part 15 of the FCC Rules.

TECHNICAL CHARACTERISTICS	EMI-3m
<b>AUXILIARY SUPPLY</b>	
Rated voltage Us	9.5...35 VDC - 9.5...27 VAC
Operating limits	-
Power consumption	< 5W
Optional backup battery	Li-Poly
<b>MODEM GSM/GPRS</b>	
Frequency bands	Quad band 850 / 900 / 1800 / 1900 MHz
Output power	Class 4 for GSM850 Class 4 for GSM900 Class 1 for GSM1800 Class 1 for GSM1900
<b>SIM INTERFACE</b>	
Type of SIM	U-SIM compatible
<b>GSM/GPRS ANTENNA CONNECTION</b>	
Type of connector	SMA o FME
Type of connector	
Connection	RS232 (RJ45 connector)
Baud-rate	Programmable 300 ... 115200 bps
<b>INSULATION</b>	
Insulation voltage	3kVAC for 1 minute
<b>AMBIENT CONDITION</b>	
Operating temperature	-40...+85°C
Storage temperature	-40...+90°C
<b>CERTIFICATIONS AND COMPLIANCE</b>	
Comply with standards	EN 60950-1:2006, EN 60950-1 A11:2009, EN 60950-1 A1:2010, EN 60950-1 A12:2011, EN 50385:2002 EN 301 489-7 V1.3.1:2005-11, EN 301 489-1 V1.9.2:2011-09 EN 301 511 V9.0.2:2003-03

OPTIONS EXTERNAL GSM ANTENNA					
ORDER CODE					
STRIP + SMA		Adhesive antenna for non-metallic surfaces.	MiniSTUB SMA		Antenna to be fitted directly on connector.
STRIP + FME			MiniSTUB FME		
MAGNETIC + SMA		Magnetic antenna for metallic surfaces.	MiniFINGER SMA		Multi band outdoor antenna. Mounting: Wall / Pole
MAGNETIC + FME			MiniFINGER FME		
BODY SMA		Body mount outdoor antenna. IP69K	FINGER SMA		Multi band outdoor antenna. Mounting: Wall / Pole
BODY FME			FINGER FME		



### MECHANICAL DIMENSIONS EMI-3m

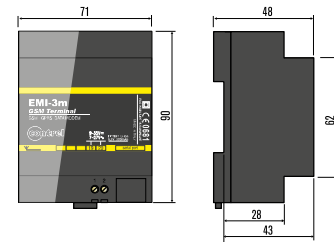

### WIRING DIAGRAMS EMI-3m

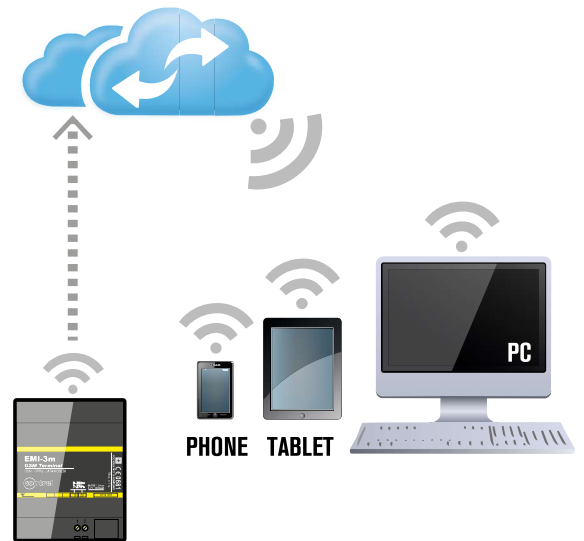

EMI-3m  
MODEM  
GSM-GPRS

Multimeter  
EMM-μD3h

Multimeter  
EMM-μD3h

Modbus  
RS485



EMI-10m  
Gateway

Modbus RS485

# EMI 5s

## COMMUNICATION DEVICES PROFIBUS DP/RS485 CONVERTER

Converter/Gateway to control equipments with Modbus protocol within an installation Profibus.



### PROFIBUS CONNECTOR

PIN	FUNCTION	PINOUT
1	Shield	
2	Disconnect	
3	RxD/TxD-P (B)	
4	CNTR-P	
5	DGND	
6	VP	
7	Disconnect	
8	RxD/TxD-N (A)	
9	Disconnect	

### TECHNICAL CHARACTERISTICS

#### EMI 5s

#### AUXILIARY SUPPLY

Rated voltage Us	80 ... 240 VAC/DC - 20 ... 60 VAC/DC
Power consumption	4 VA

#### PROFIBUS INTERFACE

Baud-rate	9.600 bps - 19.200 bps - 45.450 bps - 93.750 bps - 187.500 bps - 500.000 bps - 1.5 Mbps - 3 Mbps
Supported protocol	Profibus DP-VO
Type of connector	DB9F

#### INSULATION

Insulation voltage	3kV for 1 minute
--------------------	------------------

#### AMBIENT CONDITION

Operating temperature	-10...+60°C
Storage temperature	-25...+70°C

#### HOUSING

Version	6 module
Degree of protection	IP52
Weight	500g

#### CERTIFICATIONS AND COMPLIANCE

Comply with standards	EN 61000-2, EN 61000-4
-----------------------	------------------------

### OPTIONS

ORDER CODE	DESCRIPTION
EMI-5s	For EMM, EMA, CTT and HRI instruments
EMI-5s-D	For energy meter MID approved

### WIRING DIAGRAMS EMI-5s

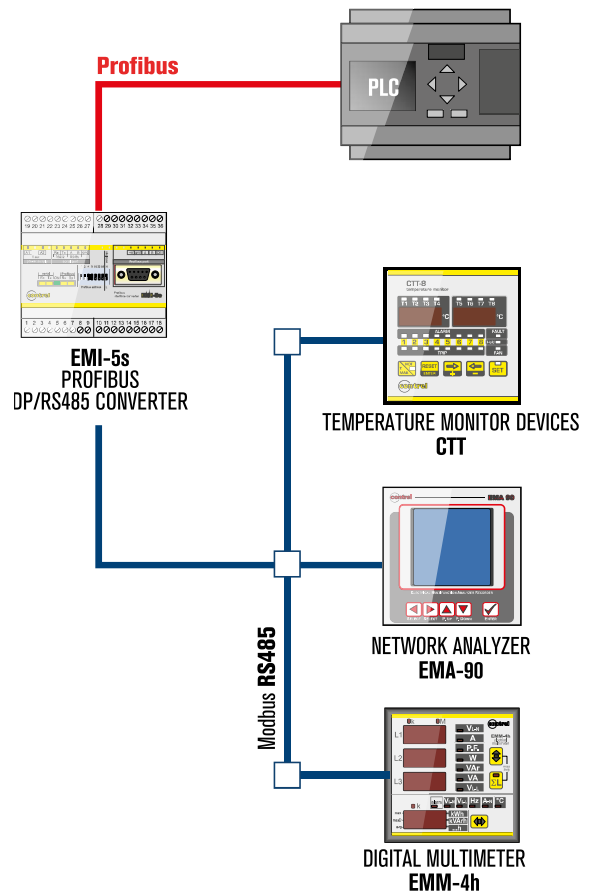

### MECHANICAL DIMENSIONS EMI-5s

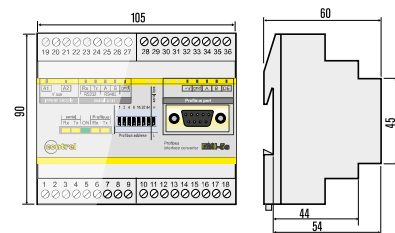

## COMMUNICATION DEVICES

The monitoring of electrical networks often use a high-speed Ethernet backbone to collect data from multiple devices and share information among users. The Ethernet Gateway **EMI-10L** can help to reduce the cost and complexity of connecting, configuring and managing a network of meters, sensors and other remote tools.

It provides reliable connectivity between Modbus serial devices and TCP/IP networks, without changing their existing infrastructure and is perfect for converting from a system based on a serial bus system based on Ethernet.

The **EMI-10L** allows users to configure the Ethernet parameters, the parameters of the serial communication and perform a possible solution of the problems through a web interface with a detailed diagnosis of the communication.

The **EMI-10L** supports 10BaseT and 100 BaseT.

This Ethernet gateway enables the integration of up to 32 serial Modbus devices.

### BENEFITS

Increase your efficiency allowing you to make quick decisions based on data made available to you:

- Access simple, fast, shared information from all electrical network products via Modbus TCP / IP
- Network architecture and flexible modular
- Transfer of data to Modbus RS485 to Ethernet Modbus TCP / IP.

### COMMUNICATION

- Use your existing LAN infrastructure to reduce the cost of lines of communication and network management
- Fast 10 or 100 megabits per second, Ethernet communications eliminates bottlenecks transferring monitoring data to the same network speed.

### DESCRIPTION

- Ethernet 10 / 100Base-T
- RS485 serial interface
- Integration of up to 32 serial devices Modbus
- Support for Modbus TCP/IP serial master
- Web interface for configuration, diagnostics and maintenance
- Customizable security through different levels of access (read-only access or full)
- Log-in safe with a password
- Languages available in Italian, English and German

TECHNICAL CHARACTERISTICS	EMI-10L / EMI-10M
<b>AUXILIARY SUPPLY</b>	
Rated voltage Us	100 ... 240 VAC - 24 VAC/DC
Power consumption	4 VA
<b>RS485 SERIAL INTERFACE</b>	
Baud rate	Programmable 1200 ... 115200 bps
Protocol	Modbus RTU
Number of connected instruments	32 max
<b>ETHERNET INTERFACE</b>	
Network interface	RJ45 Ethernet 10BASE-T o 100BASE-T (auto-sensing)
Protocols supported	HTTP, Modbus TCP/IP
<b>INSULATION</b>	
Insulation voltage	3kVAC for 1 minute
<b>AMBIENT CONDITION</b>	
Operating temperature	-10...+60°C
Storage temperature	-25...+70°C
<b>HOUSING</b>	
Version	3 modules
Degree of protection	IP52
Weight	100 g
<b>CERTIFICATIONS AND COMPLIANCE</b>	
Comply with standards	EN 60950-1:2001, EN 60950-1 A11:2004, IEC 60950-1:2005, EN 60950-1 A11:2006 A1:2010 A12:2011, EN 61000-2, EN 61000-4

OPTIONS	
ORDER CODE	DESCRIPTION
EMI-10L	Ethernet Gateway
EMI-10M	Ethernet Gateway + log memory



### SYSTEM ARCHITECTURE

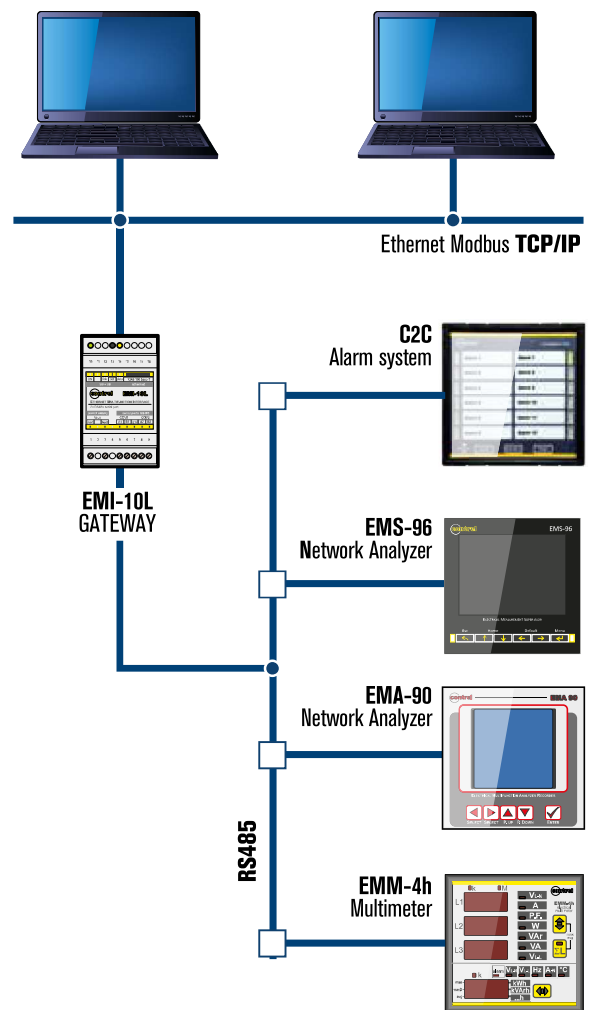

### MECHANICAL DIMENSIONS EMI-10L / EMI-10M

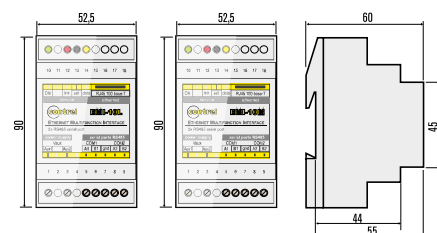

# EML 16

## DATA CONCENTRATOR

The data concentrator EML-16 provides a function of collected pulses and an interface to supervisory systems. The EML-16 can be applied as a tool for counting of consumption of energy meters, water, gas, heat, etc. It supports RS485 communication and TCP/IP communication.



### TECHNICAL CHARACTERISTICS EML 16

AUXILIARY SUPPLY	
Rated voltage Us	90 ÷ 260 VAC/CC 20 ÷ 60 VAC/CC
Operating limits	±15%
Power consumption	4,5VA
Frequency	50 - 60 Hz
COUNTER INPUTS	
Number of inputs	16
Voltage presents on the inputs	24 - 48 - 115 - 230 VAC/CC
Current input	5mA max
Type of inputs filter	Digitale
RS485 SERIAL INTERFACE	
Baud-rate	Programmable 1200 - 115200 bps
Protocol supported	Modbus RTU
ETHERNET INTERFACE	
Network interface	RJ45 Ethernet 10BASE-T o 100BASE-T (auto-sensing)
Protocols supported	HTTP, Modbus TCP/IP
INSULATION	
Insulation voltage	2,5kVAC for 1 minute
AMBIENT CONDITION	
Operating temperature	0...+60°C
Storage temperature	-20...+80°C
HOUSING	
Version	6 module
Degree of protection	IP52 on front IP20 Housing and terminals
Weight	500 g
CERTIFICATIONS AND COMPLIANCE	
Reference standards	EN50082-1, EN50082-2, EMC 89/336/EEC

### OPTIONS

ORDER CODE	DESCRIPTION
C1	20 ÷ 60 VAC/CC
24	Input voltage 24VAC/CC
48	Input voltage 48VAC/CC
115	Input voltage 115VAC/CC
230	Input voltage 230VAC/CC

### COMMUNICATION PORTS

485	RS485 serial interface
ETH	Ethernet interface with Web server function

### WIRING DIAGRAMS EML 16

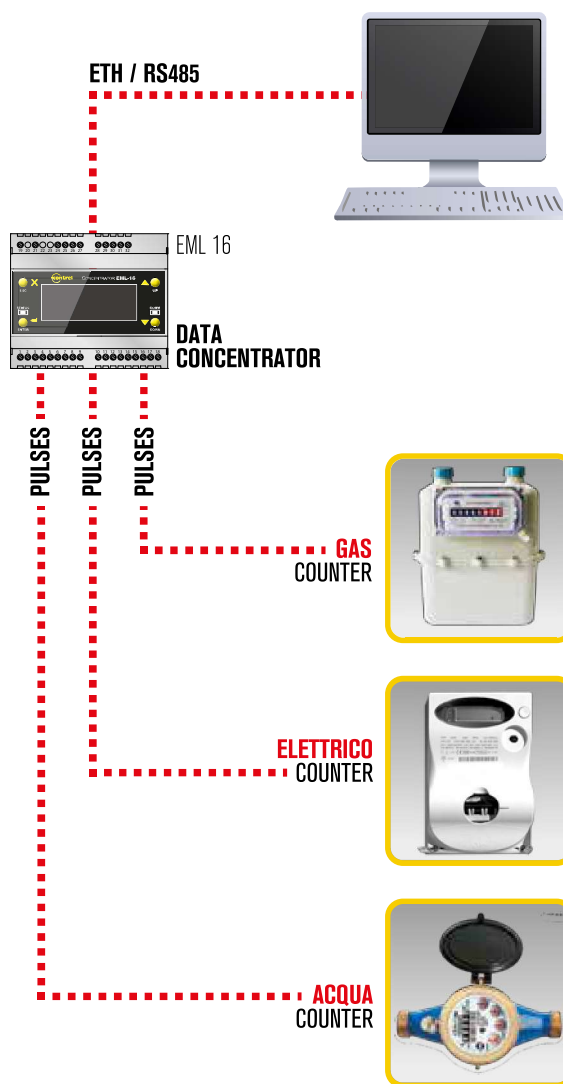

### MECHANICAL DIMENSIONS EML 16

